

Dosistar Switch

User manual

Hardware Rev: 1.8
Software 14
Software: September 2013

Index

Menu Structure	3
Navigating the menu	4
Use the menu	4
Normal operation	4
Manage customer consumption	5
View and delete the customer's consumption	5
Select customer.....	5
Overall Consumption	5
Dosing charges	6
Manage Flowmeter-Settings	8
Select flow-meter.....	8
Set flow-meter calibration value from flow-meter-manual.....	8
Calibrate flowmeter-value.....	8
Emergency operation mode	9
Activate the emergency operation mode	9
Alarm level	9
Wiring the Dosistar	10
Help for choosing the correct flowmeter	11
Technical data:	12

Menu Structure

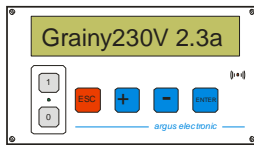

startup message

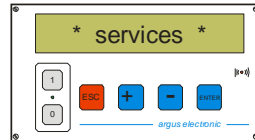
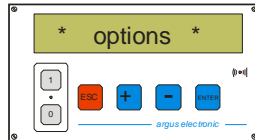
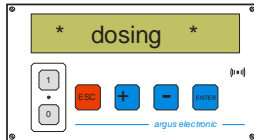

main menu

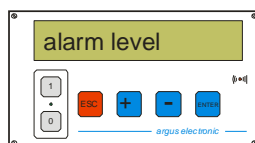
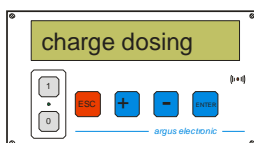
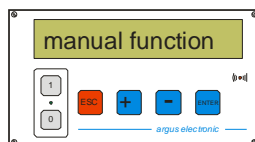
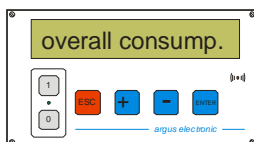
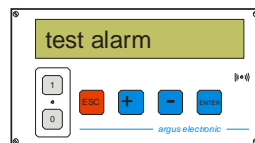
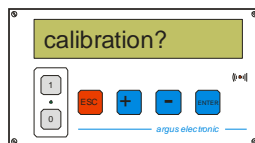
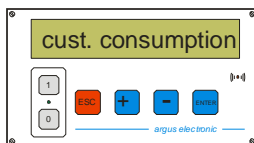
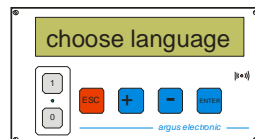
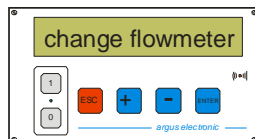
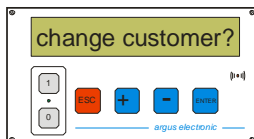
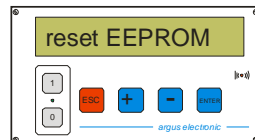
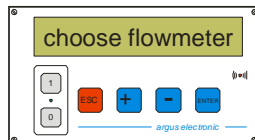

submenus

The main menu has two menu items: „*Dosing*“ and „*Options*“, each with several sub-menu items.

Navigating the menu

After switching on the Dosistar starts in the sub-menu item „Start“ of the main-menu „*Dosage*“. Additionally customer number and customer consumption is shown. With the Plus/Minus buttons you can reach the other sub-menu items. Use the ESC key moves from the lower menu level to the main menu level. Chose the item again with plus/minus and select the item with ENTER.

Use the menu

Normal operation

After switching on the Dosistar start in the Menu Dosing/Start. Customer number and customer consumption will be shown. The ENTER-key starts the dispensing process. The display shows the current customer number (K1..K9), the amount spend for the client and the current flow.

Enter or ECS- key terminates the dosage.

While the contact D2 is open, the dosing stops with the message „standby“.

If the contact D1 opens (vacancy detector) the dosing breaks with the „Conveyer empty“ message. The warning relays toggles periodically. The pump will not start again when the contact is closed. The Enter-key must be confirmed by the warning, the unit returns to Start-menu.

During dosing the pulses of the flowmeter will be count and analyzed to calculate the current flow und consumption.

The pump will be turned off, if no pulses are be triggered. This is to avoid damages. The display shows the message „running dry“ and the warning relays will toggle periodically

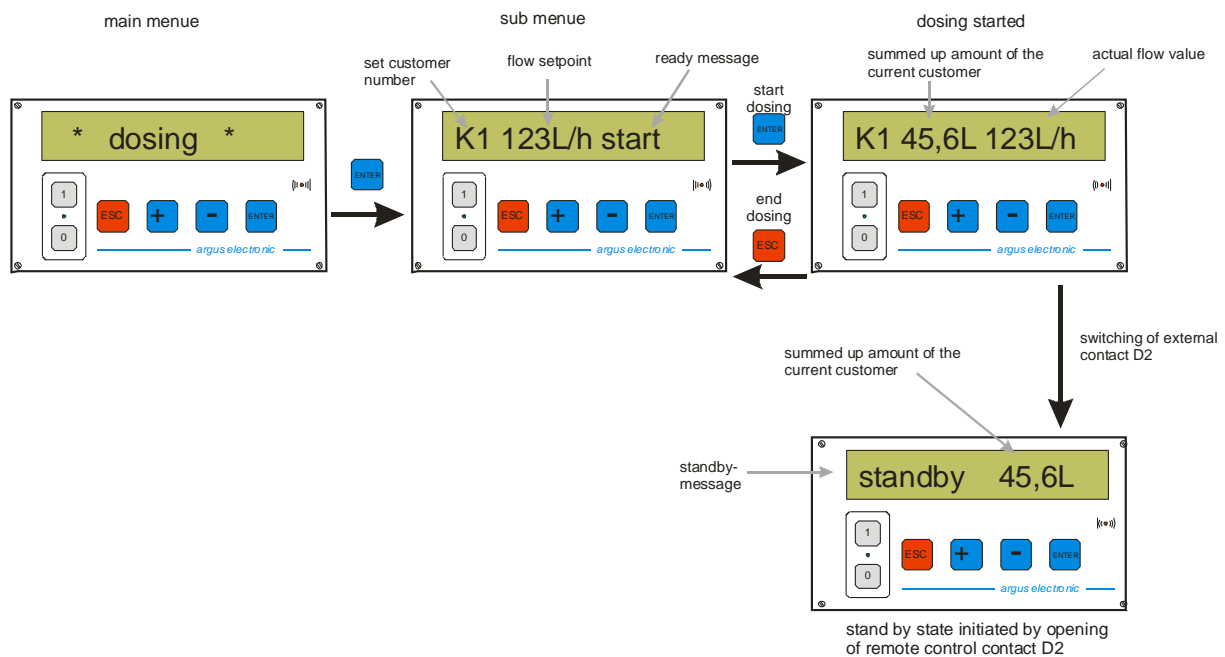

Manage customer consumption

The Dosistar stores accumulates the volume consumption from 9 clients (K1..K9). In the menu item "customer consumption" the amount of individual customers can be displayed and deleted. The current customer is set in the menu item "select customer".

View and delete the customer's consumption

- Navigate to *Dosing*/customer consumption
- Enter-key: the amount of current customer will see
- With the Plus/Minus – key you switch between different customers
- Leave the menu item with ESC **or**
- Push Enter to set the value to zero.

The maximum consumption of a single customer can be 99999 liters.

Select customer

- Navigate to „select customer“ and push Enter
- Select the customer with the Plus/Minus –keys.
- Push Enter.

Overall Consumption

The total consumption accumulates the total volume of fluid pumped up to a total of 999999 liters. The total amount can be displayed and deleted in the item „overall consumption“ by pressing Enter. This action is only available if you input a correct security code. After the message "CODE" you have to use the + and – keys to input the vendor-specific codenumber and confirm this with ENTER.

BEWARE:

With the overall consumption, you also delete the consumption of all customers.

Dosing charges

The Dosistar can dispense batches of 1 liter to 999 liter automatically. The dosing can be started with an external contact D2 or with the Enter-key.

The manual dosing of batches

The contacts D2 must not be connected.

- Navigate to Item „*Dosing*-Dosing charge“.
- With the Plus and Minus keys you can set the volume of the batch. Then press Enter.
- The display shows (for example) „C 20L ready“.
- The next press on the Enter-key starts the dosing.
- The display shows the customer-number, the residual volume and the current flow.
- If the batch was fully dosed, the pump is switched off
- With a new push to the Enter-key it starts again.
- With the ESC-key you can break the dosage every time.
- You can pause and continue with the Enter-key.

The automatically dosing of batches

For automatically or remote controlled dosing of batches you need an external (remote control) switch, connected to D2 (normally open). A short connection of the switch (1s) is sufficient to start the dosing of a batch.

- Navigate to Item „*Dosing*-Dosing charge“.
- With the Plus and Minus keys you can set the volume of the batch. Then press Enter.
- The display shows (for example) „C 20L ready“.
- The Dosistar is now waiting for the switch in D2.
- If the Switch was closed for a short time, the Dosistar starts to pump automatically and ends if the charge is complete.

The Terminals D2 (switch) must normally open and only closed for a short time to start the dosage. If the switch is permanently closed, the Dosistar is first waiting for open contacts. In this case the display message is „!D2 geschlossen!“

*In the modus „dosing charge“ the terminal D1 has no function.
The consumption of the selected customer is summed.*

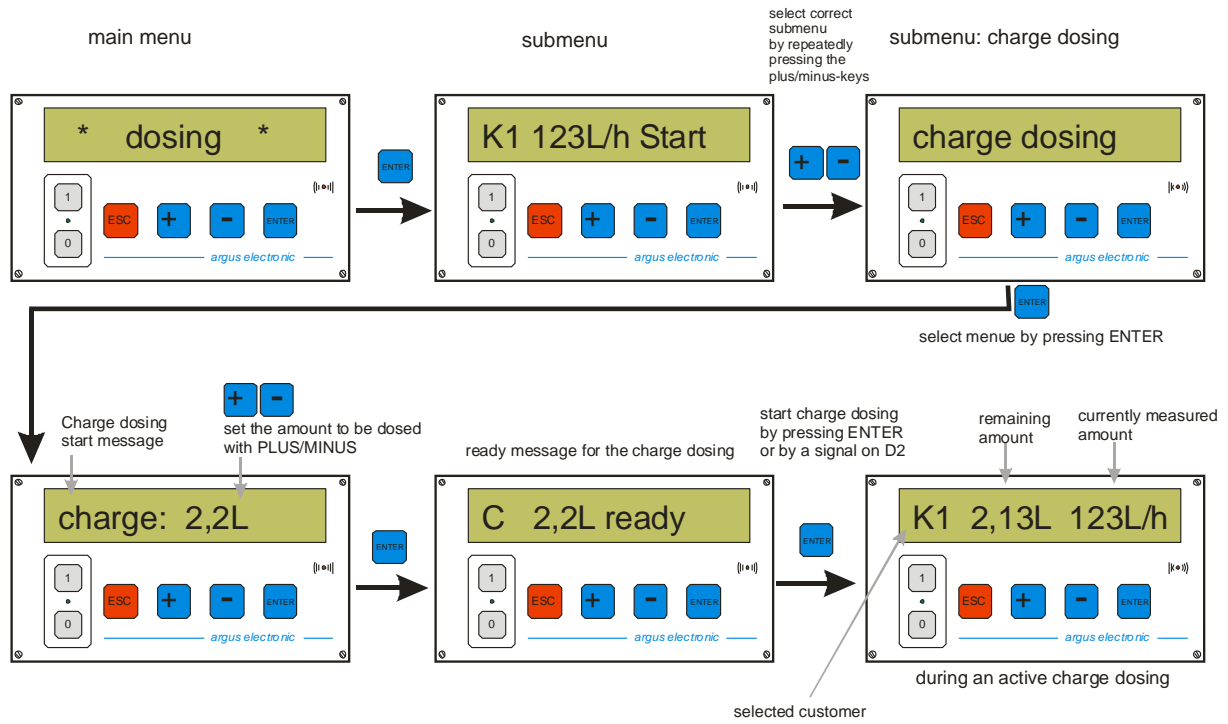

Manage Flowmeter-Settings

The flowmeter emits pulses, while liquid flows through it. The pulse count is proportional to the volume flow. The pulse-count per liter is the characteristic value. (Pulse/Liter). It depends from flow meter design, and from the viscosity and temperature of the fluid. That's why the flowmeter has to calibrate first. The Dosistar has 9 storage places for flowmeter calibration values. (DFM1..9)
The characteristic value can be entered from the manual, but it is better, to calibrate with the specific fluid under real conditions.

Select flow-meter

- Navigate to item „Choose FlowMeter“
- Enter-key and the actual flow meter calibration value will be shown.
- With the Plus/Minus- keys you can choose the flow-meter, you want.

Set flow-meter calibration value from flow-meter-manual

- Navigate to „Set FlowMeter“.
- Choose the storage place of the flow meter you want to change. Enter-key
- Adjust the value from the manual. Take care that it has the right unit (Imp/Liter)
- Enter-key to save the value in the memory.

Calibrate flowmeter-value

You need a measuring cup between 5 to 10 liter and a tube direct from flow meter to the cup. All tubes have to be filled with liquid, no bubbles.

- Navigate to „Calibrate FlowMeter“.
- Choose the storage place of the flow meter you want to change. Enter-key
- Now choose the calibration dose according your measuring cup.
- Press Enter to start the pump.
- If the selected calibration dose is reached in the cup press Enter to stop the pump.
- The pulse count per liter is displayed.
- If it is ok, press Enter to save it.

Emergency operation mode

If there is an external failure in the system (switches, flow-meter) or you want to fill the tubes or test the pump you can use the emergency operation mode. Pay attention, because the dry-running-protection does not work in this mode.

Activate the emergency operation mode

- Navigate to „Emergency operation“. Enter.
- With the Plus and Minus keys you can turn the pump on/off.
- Leave the menu item with the ESC-key

Alarm level

The device possesses two different adjustable alarm levels. Both alarm levels can be set in the *options* → alarm level menu. They are set in L/h. If the current flowrate falls below the given alarm level for a set amount of time the alarm is triggered.

Factory settings are

- 10L/h / 10 seconds for dry running
- 20L/h / 6 seconds for under dosing.

If the dry running alarm triggers the pump stops and an error message will be displayed. This error must be acknowledged by pressing ESC before you can continue dosing.

If the underdosing alarm is triggered, the alarm relais will switch periodically. The dosing won't be interrupted.

Both alarm functions are active during charge dosing and normal dosing. They are inactive in the emergency operation mode.

In order to deactivate an alarm function, set the corresponding alarm level to 0L/h.

Wiring the Dosistar

The wiring is carried out by a specialist and very carefully. The designation of the terminals is marked on the PCB. It is important to ensure proper gauge cables and proper insulation. During installation the system has to be disconnected from power. It is important to ensure that the cable entries do not affect the density of the device.

Netz: Power 230VAC
PE Protective earth
L Phase 1
N Neutral conductor

If you use a normal plug, L and N are the current-carrying conductors.

Motor: pump-motor
PE Protective earth, connected with the motor case
M1 Phase 1
M2 Phase 2

The direction of the motor can not be changed.

K1: Potential free contact for alarm 3A 250V AC
This is for warning lamp or horn. In case of error or warning the contact will be closed and opened periodically.

K2: Potential free contact for conveyor systems 3A 250V AC
This switch closes simultaneously with the pump. You can use it to start the conveyor. In most cases (higher performance you need an additional relay.

D1: Input for level monitoring of the conveyor
This Input monitors the level of the conveyor system and stops the Dosistar if the conveyor is empty. The two terminals must be connected for normal operation (wire or level monitor contact. If it is open the Dosistar stops with the message „Schnecke leer“.

If you don't need this function, use a wire to connect the two terminals together.

D2: Input for remote control (standby/charge)
You can use this terminal to control the Dosistar from other units or using a remote control. You can connect a switch or relays contact to disconnect the terminals. The Dosistar stops. In Charge-dosing mode it is used to start dose.

If you don't need this feature you have to connect the pins in normal operation or leave it open in charge-dosing mode.

DFM: Terminal for flow-meter **Open Collector NPN**
GND: Power ground DFM Minus
IMP: Input Impulse
15V: Positive Power DFM Plus

Help for choosing the correct flowmeter

To obtain optimal results for measurement and control, it is important to choose a flowmeter appropriate for the intended flow rate. The following table serves as a first indicator.

Digma flowmeter- type	flowmeter value for water [Imp/L]	max. flow rate [L/h]	min. recommended flow rate [L/h]
1,0mm	2223	35	9
1,2mm	1787	46	11
1,5mm	1386	80	13
2,0mm	1013	139	18
2,5mm	754	164	24
3,0mm	572	293	32
4,0mm	382	435	48
5,6mm	256	498	75
7,0mm	165	1080	110

Please take note that the flowmeter values can differ for other liquids or if nozzles are used.

Technical data:

Power supply:	230V AC
Output current pump-motor:	5A 230V AC
Output current K1 and K2:	max. 3A 250V AC
Switching cycles:	minimum 1Mio. cycles
Dimension (BxHxT):	180mm x 180mm x 100mm
Protection:	IP65

The case reached its protection only with closed and locked cover. Moisture can lead to destruction of the device and malfunction.

Manufacturer:

argus electronic GmbH
Erich-Schlesinger-Straße 49d
18059 Rostock
Germany

Telefon: +49 (0) 381 - 49 68 14 40

Telefax: +49 (0) 381 - 49 68 14 49

www.argus-electronic.de
info@argus-electronic.de